

Datasheet

Suction cup FC25P Polyurethane 50, G1/8" male / M5 female

Item number: FC25P.4D.02AD



- Suitable for lifting small objects and narrow parts, also slightly domed, flat and oily surfaces, e.g., such as those encountered when handling steel sheets in press processes.
- Thanks to the high friction of the rubber material, the suction cups can withstand high forces at rapid accelerations in horizontal directions, even on oily surfaces.
- The suction cups have cleats that prevent thin objects from being disfigured.
- DURAFLEX® suction cups manufactured in a specially developed material that features the elasticity of rubber and wear resistance of polyurethane. The material does not leave any marks on the objects handled.

Technical data

Description	Unit	Value
Suction cup shape	-	Flat Concave
Suction cup design	-	Round
Characteristics (for filtering)	-	Mark free
Material	-	Polyurethane (PU)
Weight, min.	oz	0.11
Suction cup model	-	FC
Volume	in ³	0.18
Height	in	0.73
Outer diameter, min.	in	1.12
Fitting size	-	1/8"
Fitting option	-	None
Fitting style	-	Female
Fitting type	-	G-thread
Fitting material	-	Al
Suction cup model	-	FC25P
Movement, vertical max.	in	0.15
Curve radius, min.	in	1.77

Performance - Lifting forces

FC25P	Vertical (lb)	Parallel (lb)
5.91 -inHg	1.8	2.023
17.72 -inHg	4.5	2.7
26.58 -inHg	6.07	4.047

Material	
Name	Polyurethane (PU50)
Color	Blue transparent
Temperature, min. °F	50
Temperature max. °F	122
Hardness °Shore A	50

Material resistance

Alcohol	Not applicable
Concentrated acids	Fair
Ethanol	Fair
Hydrolysis	Fair
Methanol	Poor
Oil	Excellent
Oxidation	Poor
Gasoline	Fair
Wear resistance	Excellent
Weather and ozone	Excellent

Dimensional drawings

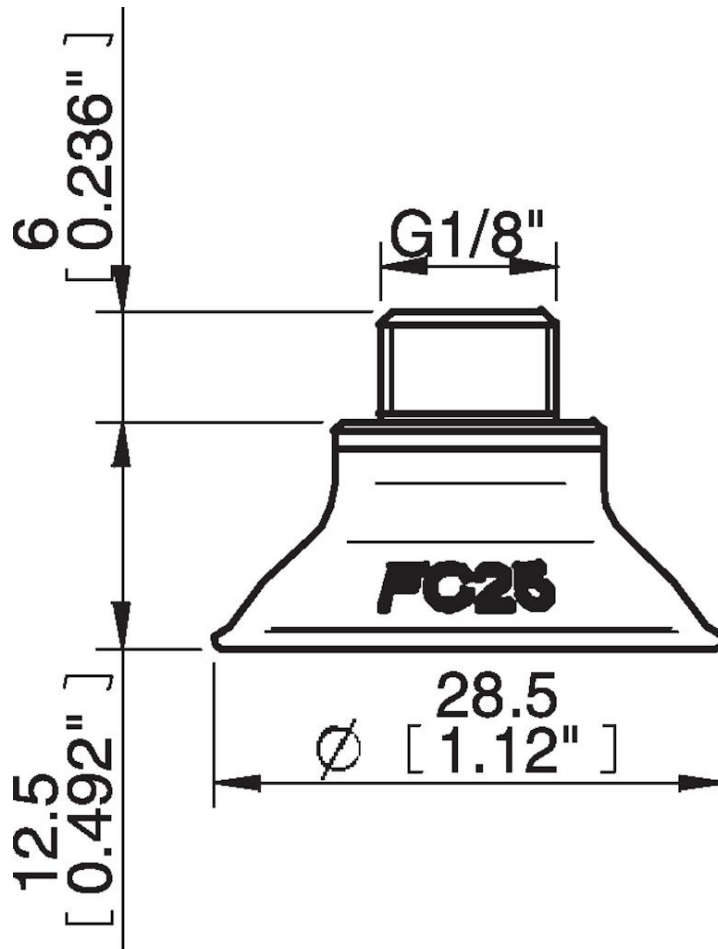

Values specified in this data sheet are tested at (unless otherwise stated):

- Room temperature (20°C [68°F] ± 3°C [5.5°F]).
- Standard atmosphere (101.3 [29.9 inHg] ± 1.0 kPa [0.3 inHg]).
- Relative humidity 20-70%.
- Compressed air quality, DIN ISO 8573-1 class 4.

Accessories

02AE | Fitting 5xM5 female

02AF | Fitting G1/8" male/M5 female, with mesh filter

02AA | Fitting M5 female

02AB | Fitting G1/8" male, with mesh filter

02AC | Fitting 1/8" NPT male, with mesh filter

02DA | Fitting M5 female, with dual flow control valve

02DC | Fitting 1/8" NPT male, with dual flow control valve

02DD | Fitting G1/8" male/M5 female, with dual flow control valve

02DE | Fitting 5xM5 female, with dual flow control valve

Spare parts

FC25P.4D | Suction cup FC25P Polyurethane 50

02AD | Fitting G1/8" male/M5 female