

Datasheet

Suction cup B-BL60-2 Silicone, 1/2" NPT male composite detectable, FCM

Item number: BBL60-2.DS40.NT12MDC.00



Technical data

Description	Unit	Value
Suction cup shape	-	Multibellows
Application	-	Food contact materials (FDA & EU), detectable
Suction cup design	-	Round
Characteristics	-	Food contact materials (FDA & EU), detectable
Material	-	Silicone (SIL)
Load, torque, max.	lb ft	9.59
Weight, min.	oz	1.044
Suction cup model	-	B-BL
Volume	in ³	5.0097
Height	in	2.70
Outer diameter, min.	in	2.36
Outer diameter, actuated	in	2.36
Fitting size	-	1/2"
Fitting option	-	None
Fitting style	-	Male
Fitting type	-	NPT-thread
Tightening torque, max.	lb ft	9.59
Fitting material	-	Composite
Suction cup model	-	B-BL60-2 FCM, detectable
Movement, vertical max.	in	1.71
Curve radius, min.	in	0.74

Performance - Lifting forces

B-BL60-2 FCM, detectable	Vertical (lb)	Parallel (lb)
2.95 -inHg	2.38	2.68
5.91 -inHg	5.33	4.81
11.81 -inHg	9.69	10.77

Material	
Name	Silicone (SIL detectable FCM)
Color	Blue
Temperature, min. °F	-40.0
Temperature max. °F	392.0
Hardness °Shore A	40

Material resistance

Alcohol	Good
Concentrated acids	Poor
Ethanol	n/a
Hydrolysis	Fair
Methanol	n/a
Oil	Poor
Oxidation	Excellent
Gasoline	Poor
Wear resistance	Good
Weather and ozone	Excellent

Dimensional drawings

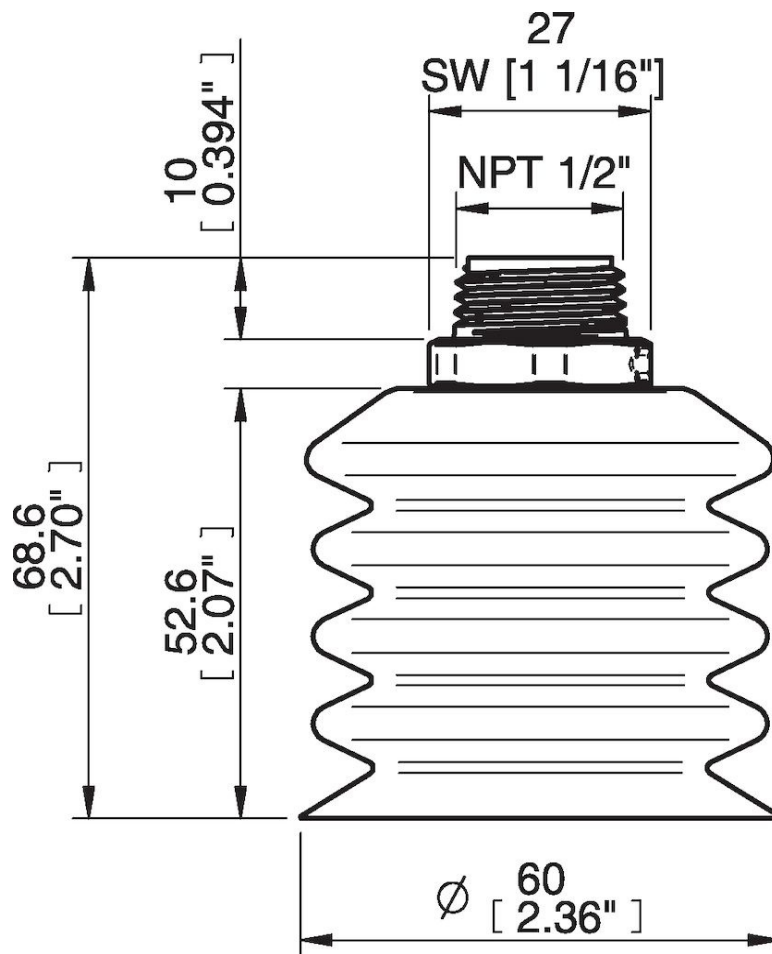

Values specified in this data sheet are tested at (unless otherwise stated):

- Room temperature (20°C [68°F] ± 3°C [5.5°F]).
- Standard atmosphere (101.3 [29.9 inHg] ± 1.0 kPa [0.3 inHg]).
- Relative humidity 20-70%.
- Compressed air quality, DIN ISO 8573-1 class 4.

Accessories

01.21.660 | Retainer clip B-BL40-2, detectable

02.07.181 | Fitting G3/8" Male, SS, B-BL

02.07.182 | Fitting 3/8" NPT Male, SS, B-BL

02.07.183 | Fitting G1/2" Male, SS, B-BL

02.07.184 | Fitting 1/2" NPT Male, SS, B-BL

02.07.190 | Fitting G3/8" Male, composite, B-BL

02.07.191 | Fitting 3/8" NPT Male, composite, B-BL

02.07.192 | Fitting G1/2" Male, composite, B-BL

02.07.193 | Fitting 1/2" NPT Male, composite, B-BL

Spare parts

BBL60-2.DS40 | Suction cup B-BL60-2 Silicone, detectable, FCM

02.07.193 | Fitting 1/2" NPT Male, composite, B-BL