

PX110 - Suction cup - G1/2" female

Item number: 0255312



- Confident grip on rough, structured and uneven materials such as wood, dry sheet metal, glass and stone.
- Soft, compliant EPDM sealing edge that closely follows surface contours for dependable sealing.
- Rigid aluminium fitting plate with integrated support pattern to stabilize thin and delicate workpieces.
- Gentle contact surfaces that help prevent marks, dents and permanent deformation.
- Compact internal volume for very short evacuation times and increased lifting cycles.
- Optional cone valve version that activates the cup only at pick, reducing air consumption by automatically deactivating cups that are not in contact with the workpiece.
- Sealing element is securely locked into the fitting plate yet can be easily replaced when worn.
- Threaded connection in the fitting plate for direct vacuum hookup or optional cone valves.
- Available in multiple diameters aligned with typical sizes used in wood, metal, glass and stone handling.

Technical data

Description	Unit	Value
Suction cup shape	-	Flat
Suction cup design	-	Round
Material	-	Ethylene Propylene (EPDM). Nitrile (NBR)
Weight, min.	oz	15.48
Suction cup model	-	PX
Volume	in ³	4.27
Outer diameter, min.	in	4.33
Outer diameter, actuated	in	5.12
Fitting size	-	1/2"
Fitting option	-	None
Fitting style	-	Female
Fitting type	-	G-thread
Fitting material	-	Al
Suction cup model	-	PX110
Curve radius, min.	in	11.81

Performance - Lifting forces

PX110	Vertical (lb)	Parallel (lb)
5.91 -inHg	36.87	
17.72 -inHg	106.34	
26.58 -inHg	157.37	

Material		
Name	Ethylene Propylene (EPDM) 20	Nitrile (NBR) 60
Color	Black	Blue
Temperature, min. °F	-40	-4
Temperature max. °F	248	212
Hardness °Shore A	20	60

Material resistance

Alcohol	Excellent	Good
Concentrated acids	Poor	Fair
Ethanol	Not applicable	Not applicable
Hydrolysis	Good	Good
Methanol	Not applicable	Not applicable
Oil	Poor	Excellent
Oxidation	Excellent	Good
Gasoline	Poor	Good
Wear resistance	Fair	Excellent
Weather and ozone	Excellent	Fair

Dimensional drawings

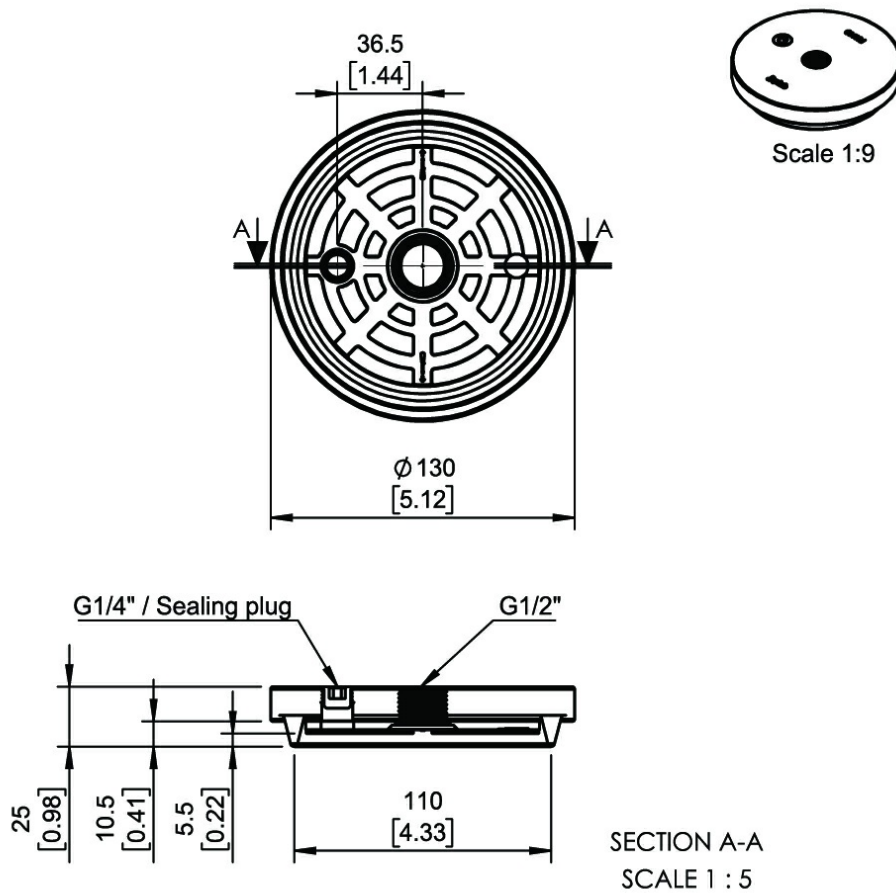

Values specified in this data sheet are tested at (unless otherwise stated):

- Room temperature (20°C [68°F] ± 3°C [5.5°F]).
- Standard atmosphere (101.3 [29.9 inHg] ± 1.0 kPa [0.3 inHg]).
- Relative humidity 20-70%.
- Compressed air quality, DIN ISO 8573-1 class 4.